

ALLEGRO (♩ = 160)

IV 4
4 47.

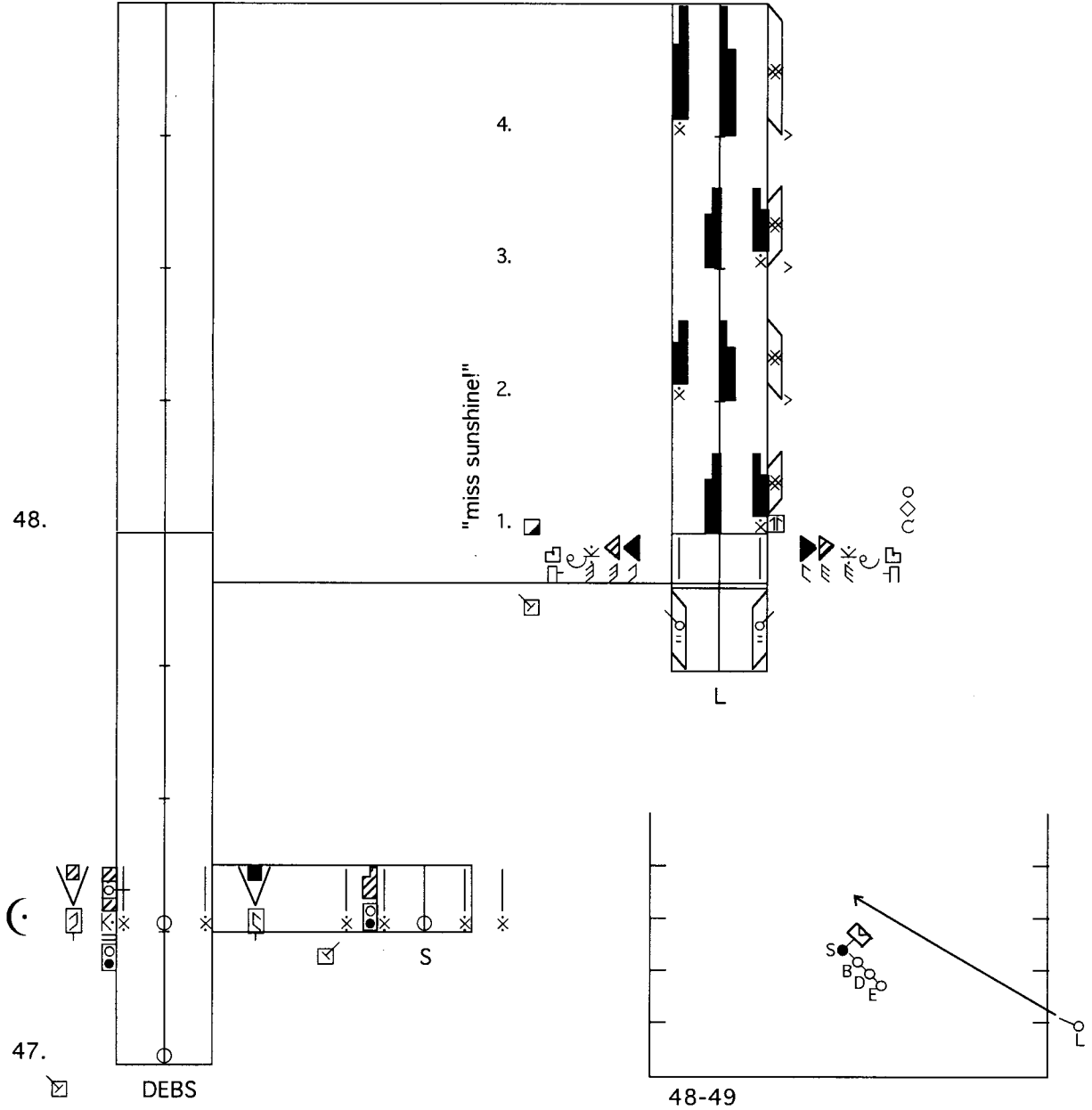

☆ Pile up for DEBS as seen from the audience:
(ms. 50-51)

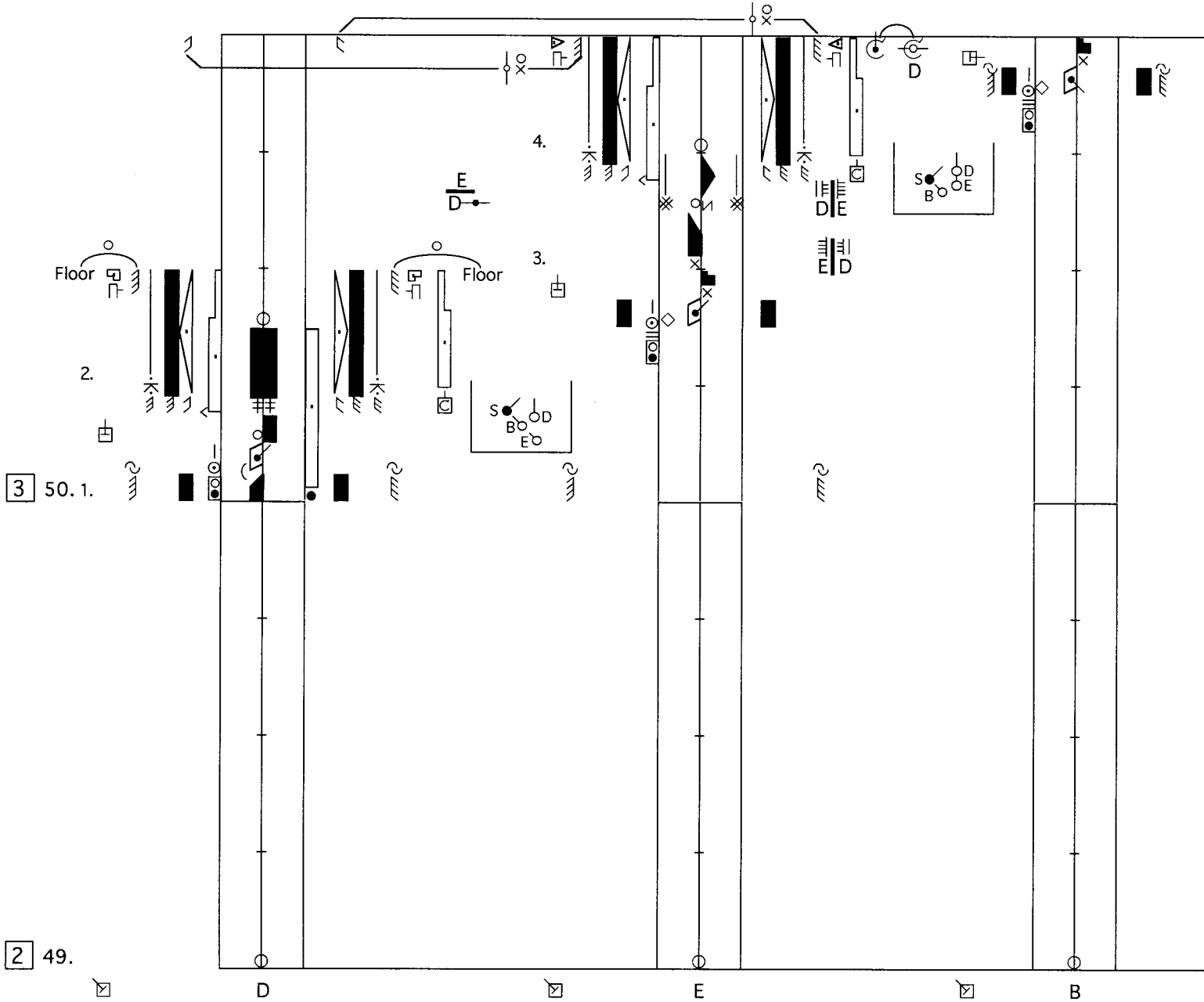
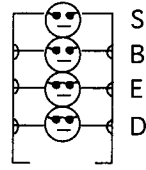

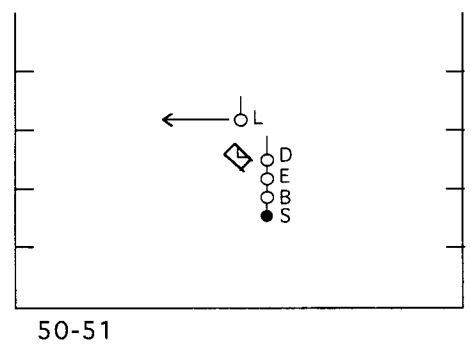
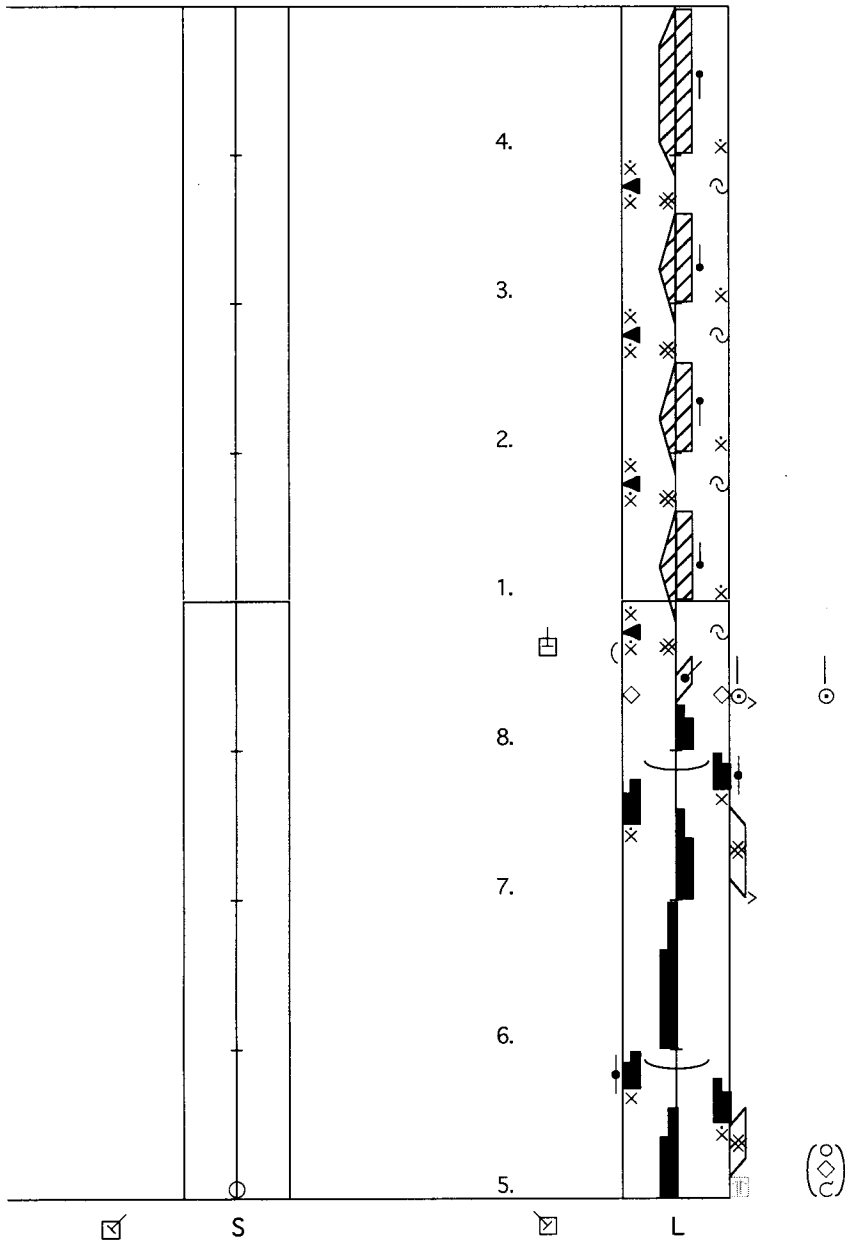

5 52.

4 51.

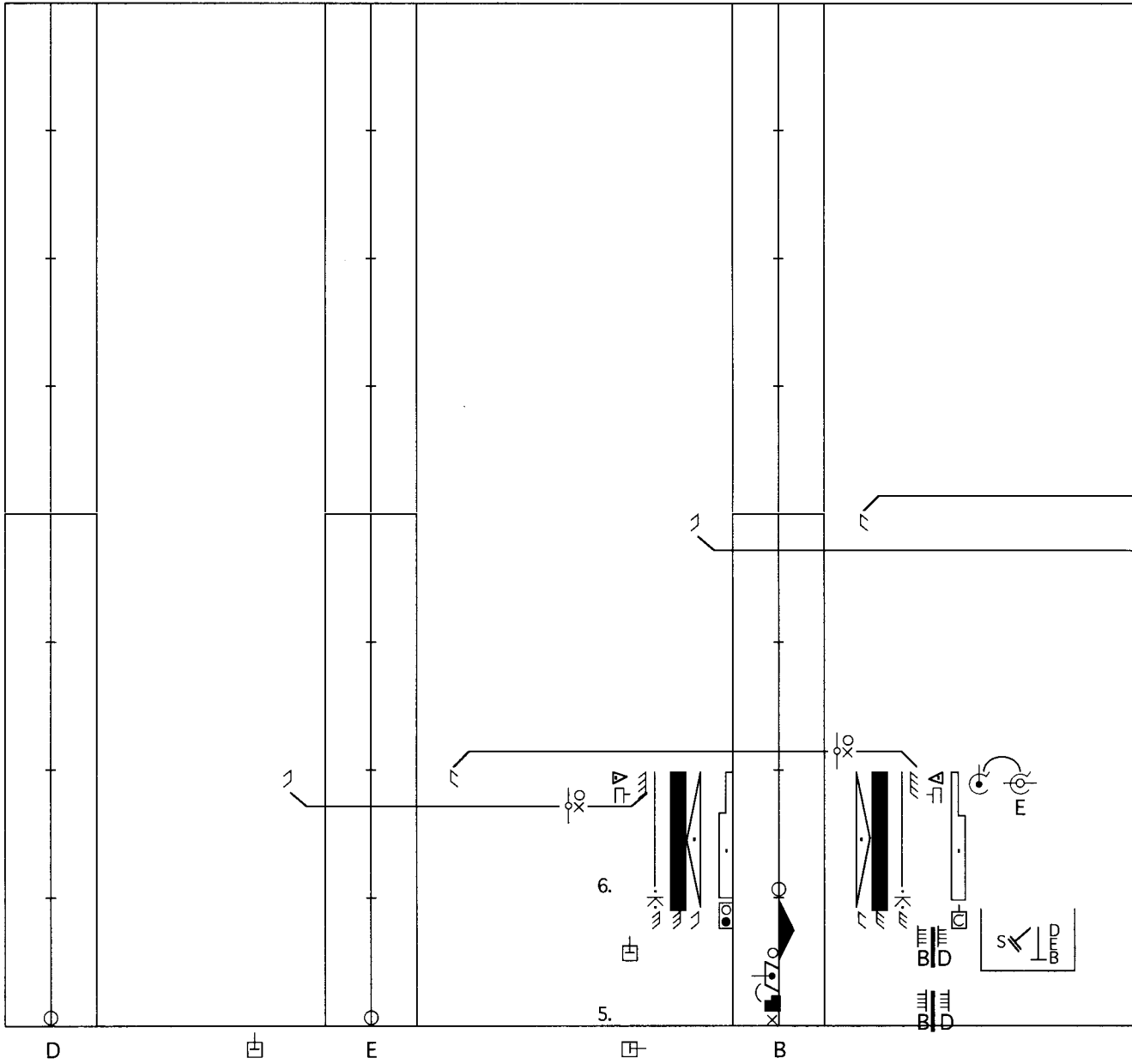

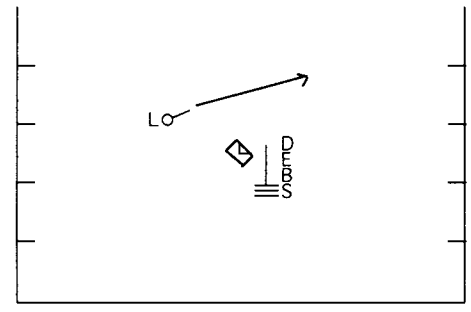

52-53

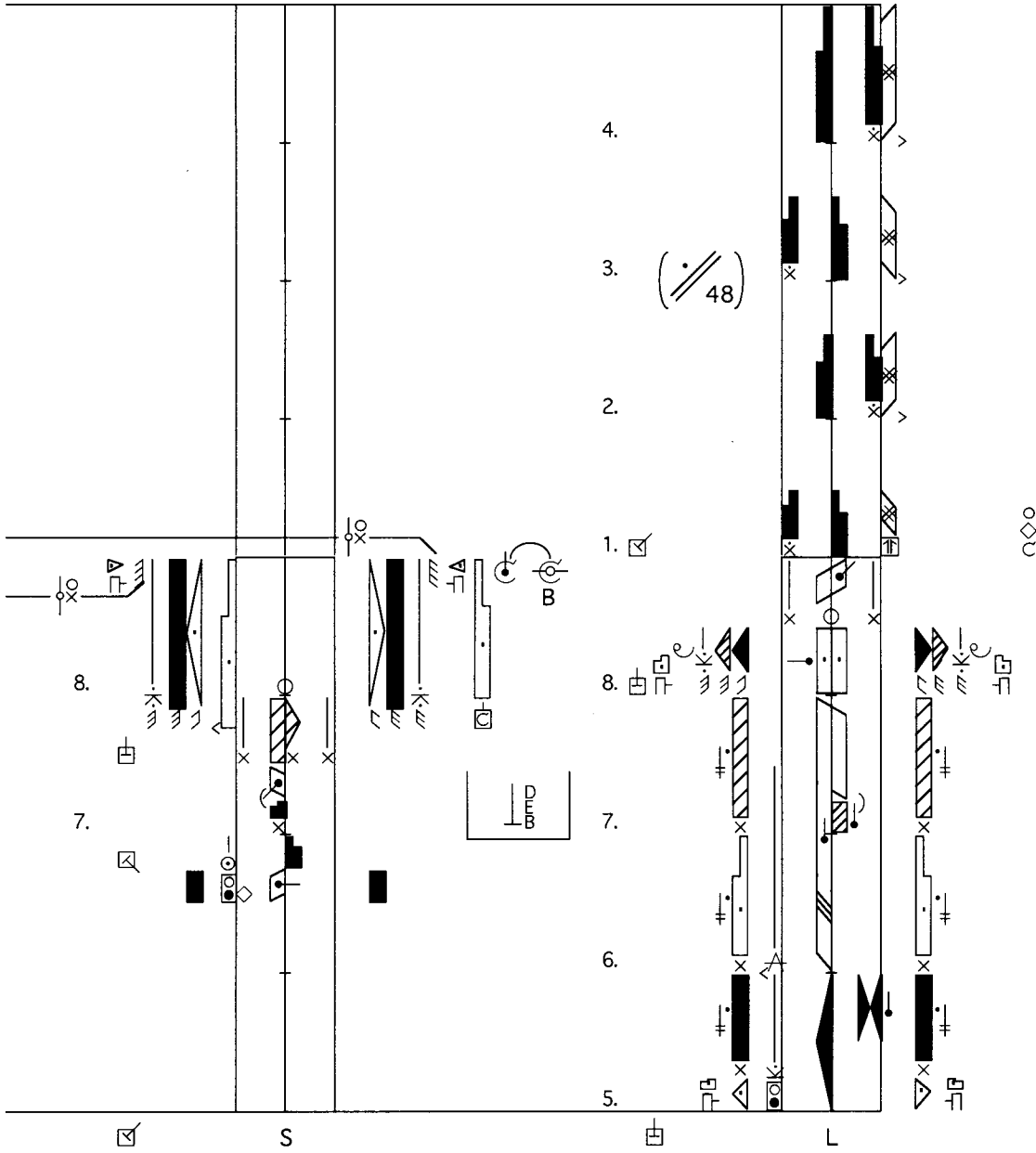

7 54.1.

4.
3.
2.

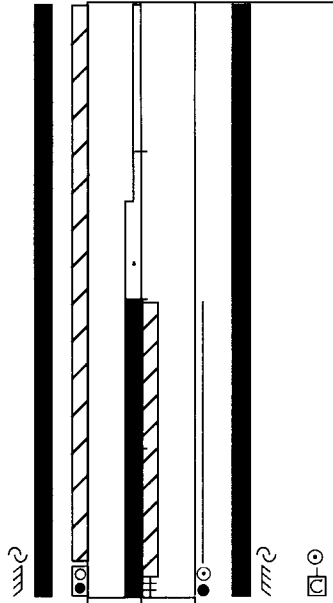

"Shuffle back just enough to give everybody a little space, but close enough to easily touch person in front."

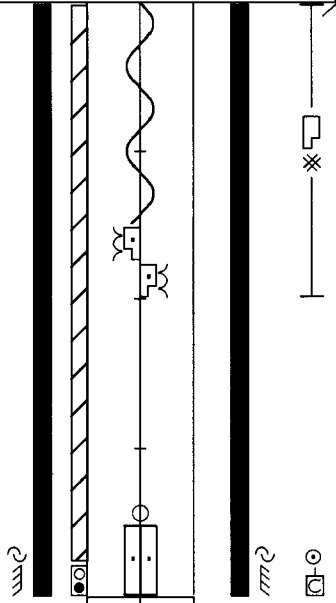

6 53.



D



E



B

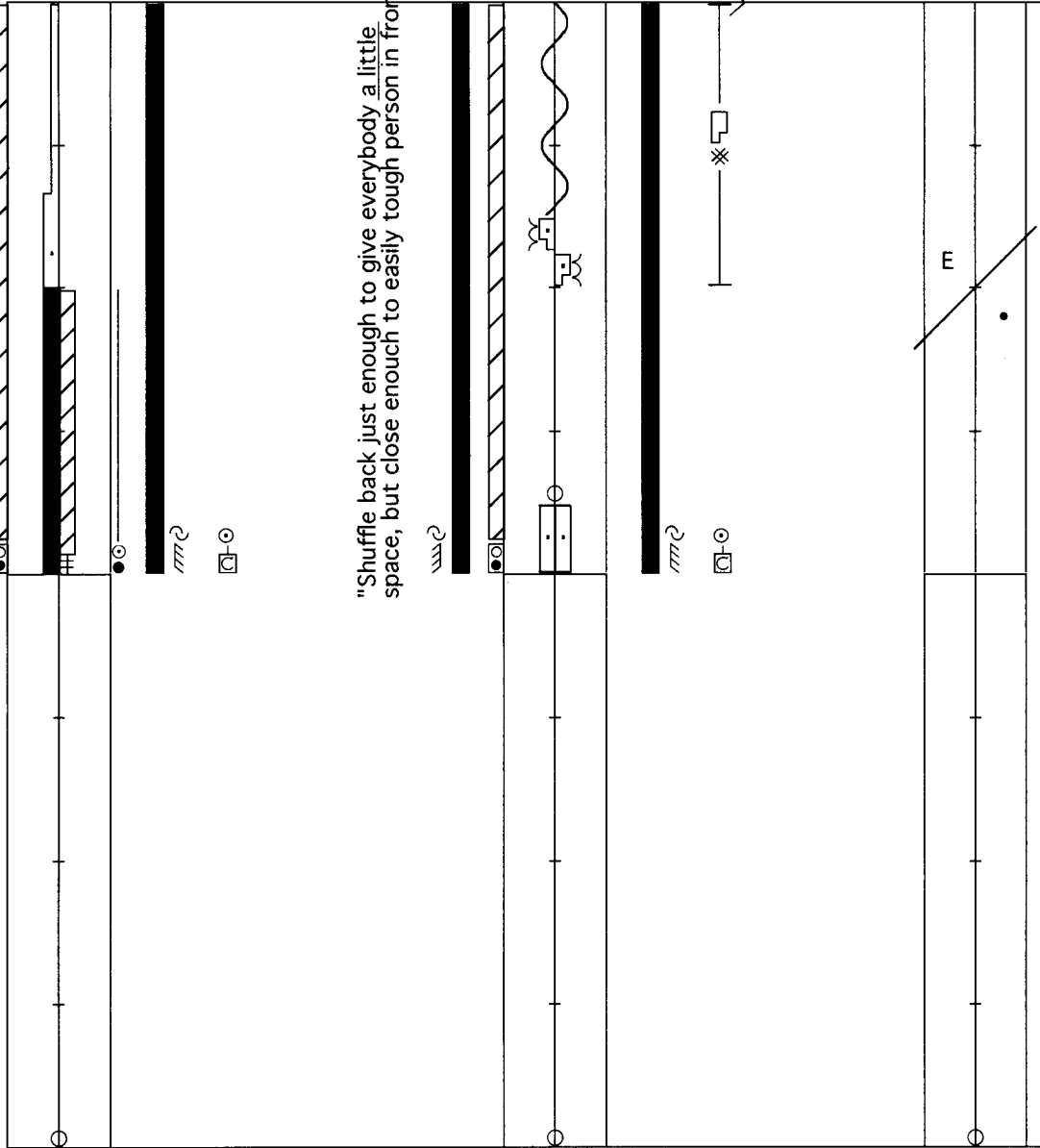

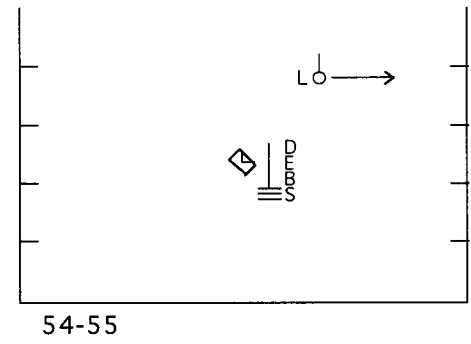
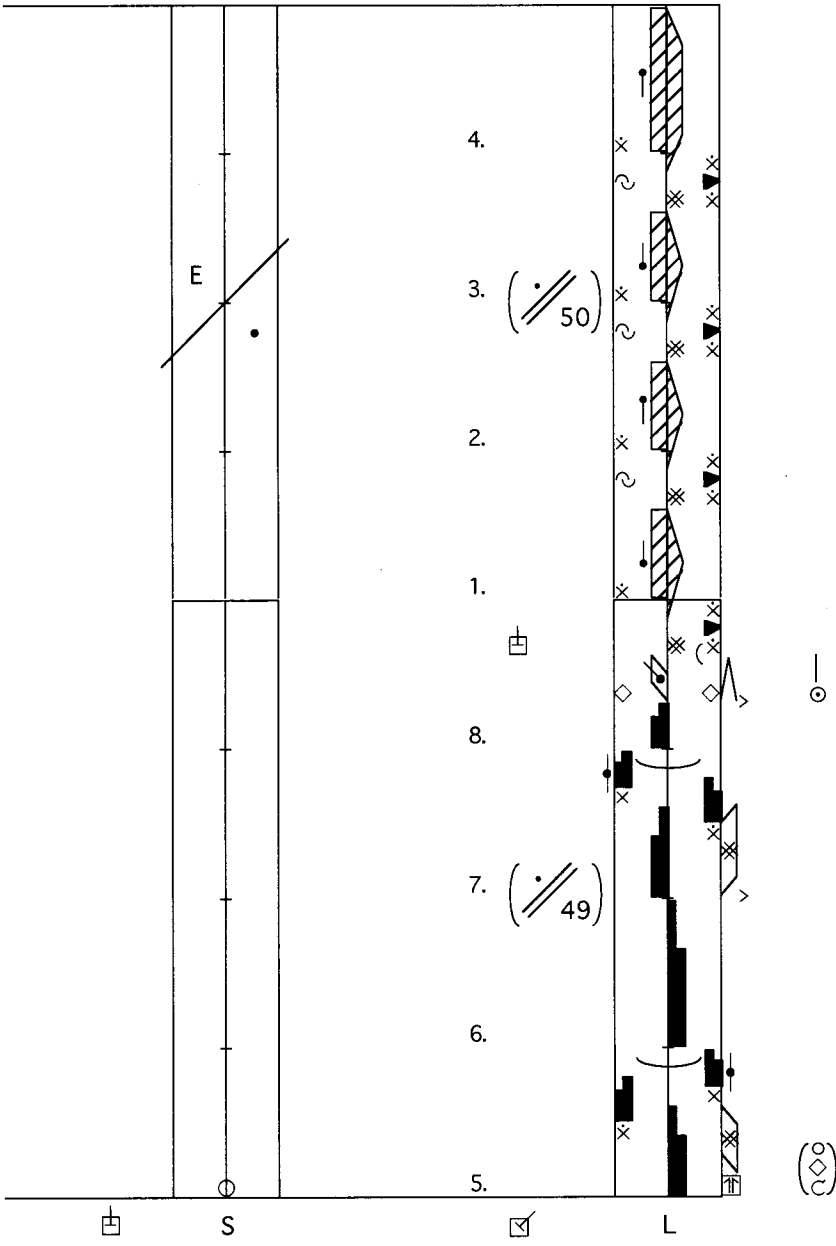

☆ Elbow grabbing for DEBS
as seen from the audience
(ms. 56)



9 56. 1.

8.

7.

6.

8 55. 5.

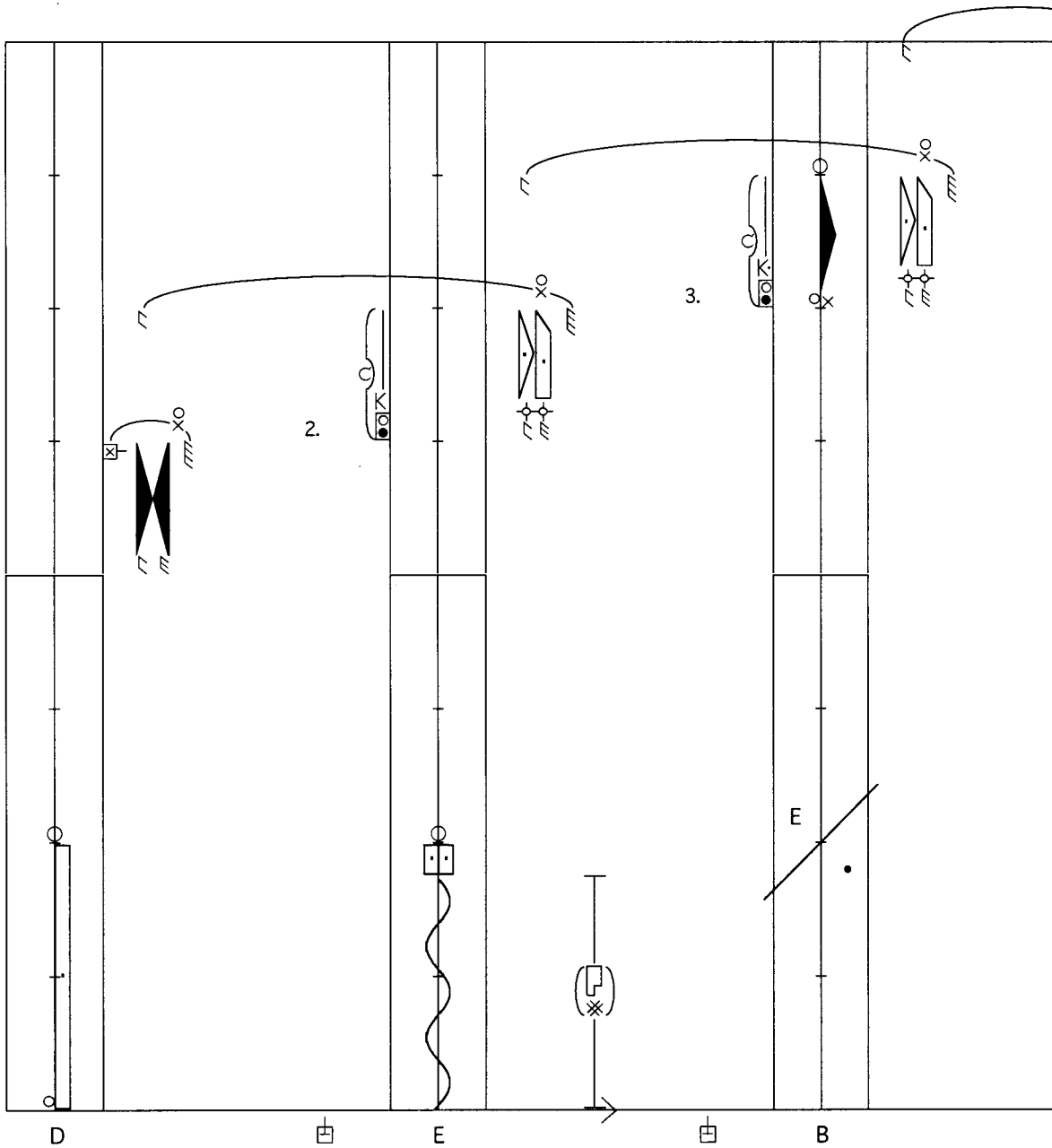

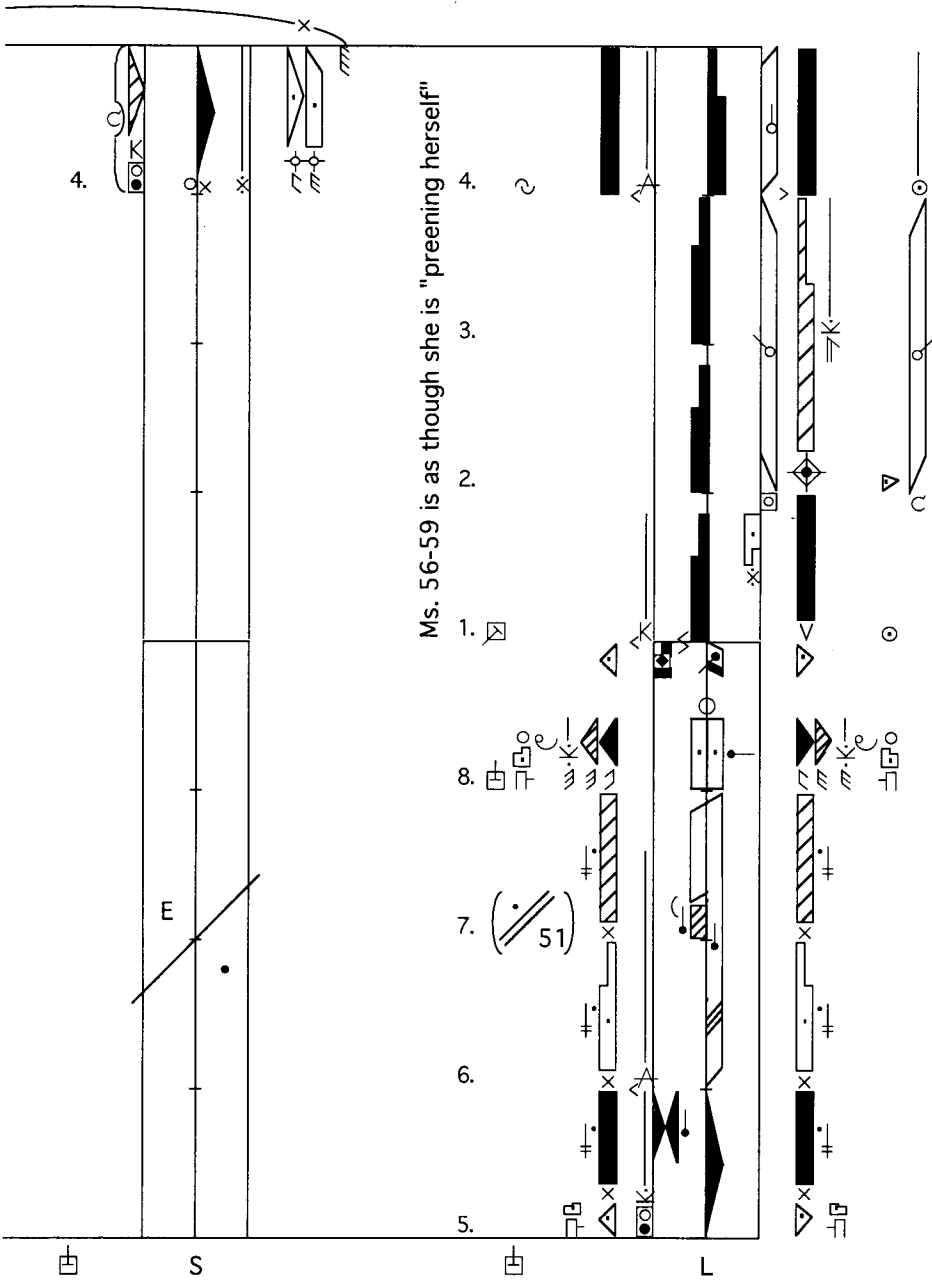

Ms. 56-59 is as though she is "preening herself"

